

Interesting
Photos
easily
obtainable
with the
Vielzweck
and the

EXAKTA
Varex

To begin with – a few general comments

The possibility of employing a modern miniature reflex camera in which ever sphere of photography imaginable is to-day no longer unique. But in judging the type of camera to use, it is important to realize which costs and extra appliances become necessary to carry out the various kinds of work. As a one-lens reflex camera, the EXAKTA Varex will hardly be surpassable in its simplicity and safety as well as regarding the limited number of accessories required with it. The reasons are quite clear: fundamentally, the EXAKTA Varex is not merely a picture-taking camera but also a universal finder. Hence, no matter which extra equipment has been attached to the camera, focusing, free from parallax, can always be performed by the finder image. There is no need whatever for any complicated optical device, or perhaps a reflex box, and the mechanical arrangements for special tasks are exceedingly simple. This means a noticeable difference, not only in practice, but also with regard to purchase costs.

The EXAKTA Varex Vielzweck corresponds in every respect to the afore-mentioned primary characteristics concerning the use of the EXAKTA Varex. In several cases, certainly, it would suffice to use a simpler supplementary device, e. g. bayonet rings and tubes alone, for close-ups, but wherever the question of efficiency arises, as it surely will in professional work, we strongly advise the use of the Vielzweck. You need by no means, for one special purpose, purchase the complete Vielzweck right away. Also this equipment – like the EXAKTA Varex itself – has been designed with a view to add standardised parts as may be required. The individual part groups of the Vielzweck can be employed either separately or in various combinations. Thus, you are in a position to buy as your budget will allow you. In other words: the growing demands of the photographer may find their best expression in the gradual completion of the Vielzweck Multi-Combination.

In the following pages of this brochure we wish to point out several important methods of using the Vielzweck, but by no means can we go into details on every possibility of using the part groups. We hope, however, to inspire our readers themselves to expand the capabilities of the Vielzweck equipment. Besides, our comprehensive and extremely informative instruction booklet for using the Vielzweck is available to all who may be interested.

Our prospectus is meant to explain in short the simplicity of mastering the following photographic tasks:

	Pages
Extreme close-ups (macrophotography and magnifier exposures)	3/4, 6/7, 10/11
Reproductions	6/7
Transparencies	5
Photomicrography	8/9
The Tripod in use.	9
Medical photography, especially magnifier exposures with electronic flash (cavities of the human and animal bodies, etc.)	10/11



Above: "Grain" (barley and wheat), Photo by H. W. Brumm, Wolzig
Left: "Water drops falling on water surface" Photo by J. Steiner, Leipzig

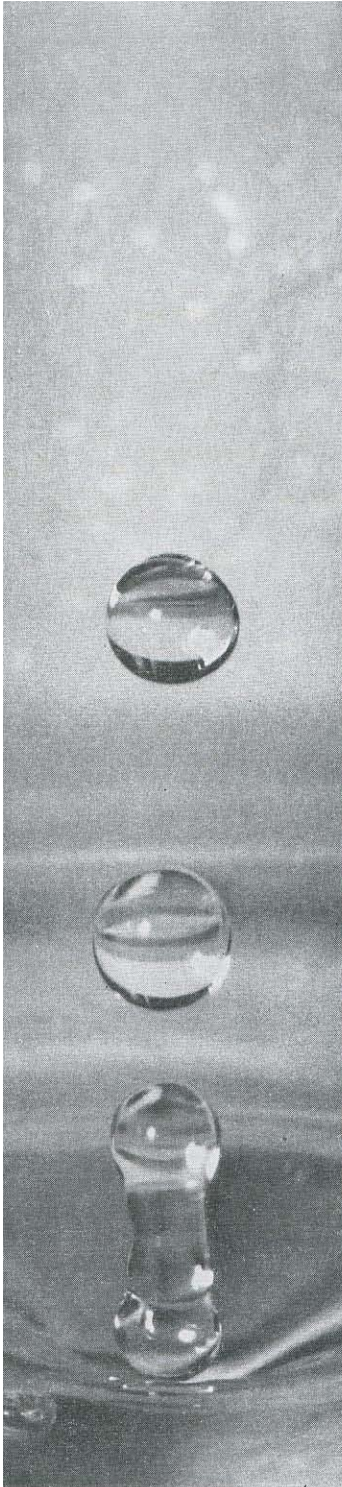

Small objects under the magnifier –

photographically speaking, this means making interesting and instructive close-up pictures in which the subject is reproduced from slightly under natural size up to several times enlarged. For technical and scientific purposes, for art and research work, convincing picture material can be produced, even from the tiniest of objects. In this little world, the amateur as well as the professional find an inexhaustible field of activity with ever new and unexpected motives. With the few picture samples given here, we merely intend to indicate the vast range of working possibilities open to the EXAKTA Varex when used with the focusing slide for short-distance exposures. This focusing slide is of great advantage:

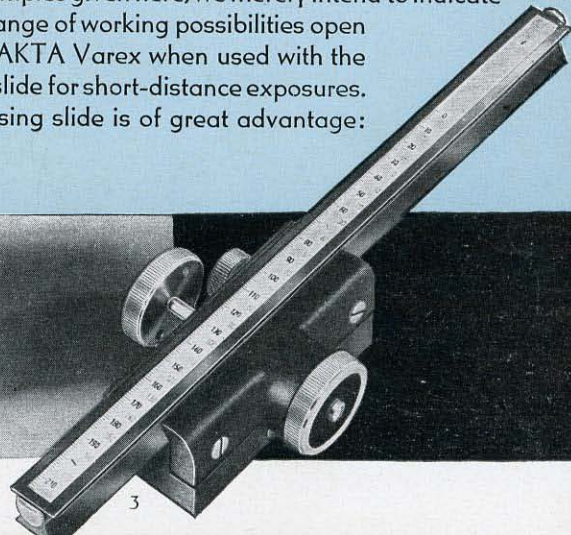

The focusing slide

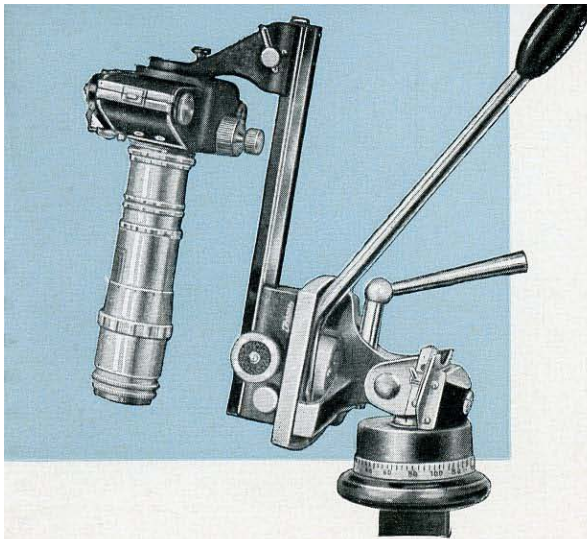

Swing angle attachment on a tripod:
Vertical position

If, e. g., the camera has been set up firmly on a tripod or on the copying stand, the image distance is variable within a wide range by means of the cog-wheel mechanism in the focusing slide. This follows, as is technically indispensable to this kind of work, that also critical focusing is performed with greatest precision. The focusing slide is used with the following component

parts, horizontally without a tripod, horizontally or vertically, if fixed to a tripod or to the copying stand (see pages 6/7). There are two methods of connecting the EXAKTA Varex and for switching from the horizontal to the vertical, or vice versa.

1. Swing angle attachment. The swing angle is a simple, movable attachment requiring the use of bayonet rings and tubes to obtain the necessary extension for close-up exposures. The swing angle attachment also serves excellently as stereo base for three-dimensional exposures of motionless objects.

2. Bellows attachment. This device will be found most convenient, the bellows allowing for continuous extension from 35 to 220 mm, which means that scale of reproduction and image distance may be changed quickly and without interrupting stops, simply by shifting the camera holder with the EXAKTA Varex on it. The degree of extension is marked on the scale. Should you wish to start focusing at infinity, you may use a lens with sunk mount.

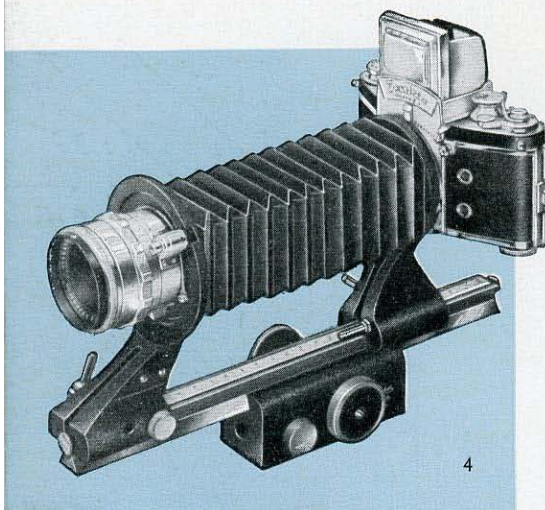

Order No.

Swing angle attachment.	155.08*)
Bellows attachment	155.10
Swing angle top.	155.03*)
Bellows top attachment.	155.02
Special lens f/2.8, 50 mm focal length, with sunk mount	128

*) When ordering, please state whether the camera in use has continental or English tripod socket.

Bellows attachment standing on a table: horizontal position

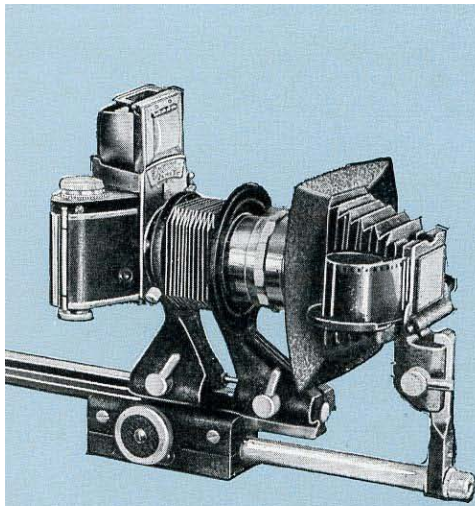

Transparency copy equipment at bellows attachment

equipment has been designed to fit the bellows attachment allowing for transparencies from black-and-white or colour negatives (or duplicate negatives from reversible colour transparencies) to be made on an optical basis. According to the well-known close-up technique, negatives are photographed on a scale of 1:1, or in smaller singled-out sections, on positive film, yielding strips which can, of course, also be cut into single slides and framed.

Just a few more words concerning the transparency copy equipment: To be used with bellows attachment, see page 4. Exposure is made with EXAKTA Varex shutter. Complete equipment may be placed on a table, or fixed to copying stand (see page 7). Rise-and-fall film gate for picture composition. Film gate takes single negatives or positives as well as film strips. Slip-in frame for mounted 5x5 cm transparencies. Even distribution of light through opal glass. Film-pressure plate keeps objects flat. Transparency Copying Screen.

Transparency copy equipment with Transparency Copying Screw. Order No. 155.04

Making your own transparencies

Projecting your photos will give you far more pleasure! The brilliant screen picture reveals all their finest details. But how about making your own transparencies with your EXAKTA Varex? For this purpose,

a transparency copy



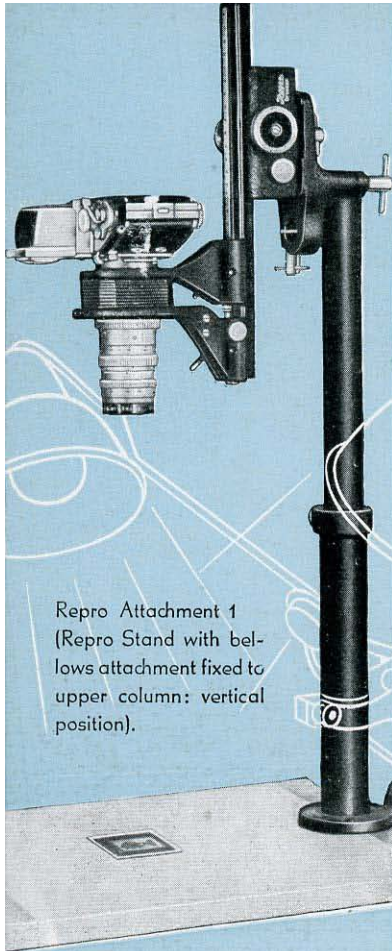

Repro Attachment 1
(Repro Stand with bellows attachment fixed to upper column: vertical position).

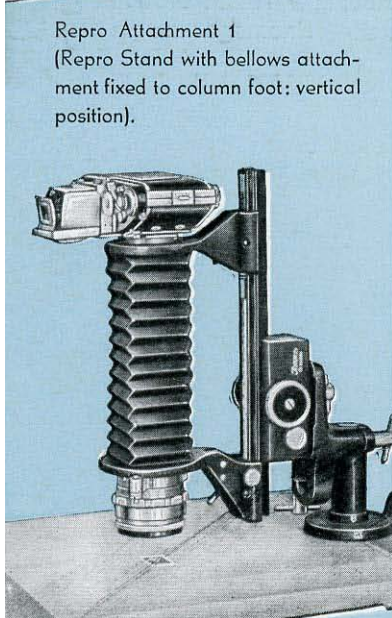

Repro Attachment 1
(Repro Stand with bellows attachment fixed to column foot: vertical position).

Reproductions may be needed anywhere!

Therefore, how convenient it is to be able to copy paintings, drawings, book and magazine illustrations, without the least trouble, with the aid of your EXAKTA Varex! The same refers to photographing documents, writings, postage stamps, coins, and many other similar objects. Photography, in this way, enables you to preserve irretrievable things in the picture or to collect illustrative documents for any conceivable purpose (lectures, archives, in exploiting common interests, etc.). This kind of reproductions is preferably done with the equipment in vertical position, as provided by the Repro Attachments 1 and 2, *Vielzweck* parts, too. It goes without saying that, in the same way, the Repro Stands can be employed also for all other kinds of close-up, etc. a sturdy table-tripods, moreover permitting to fix the taking apparatus horizontally, too. On the headpiece of the repro attachment the focusing slide is screwed which, on its part, as described on page 4, must be completed with bellows attachment (= Repro Attachment 1) or with swing angle (= Repro Attachment 2). A lightbox of some kind placed on the baseboard of the Repro Stand enables you to illuminate your object from below or with a combination of upper and lower light. Small transparencies can be made also from larger negatives.

Features! Wooden baseboard with adjusting screws to ensure steadiness. Surface of board: approx. 30 x 30 cm, sufficing for subject material of DIN A 4 (21 x 29,7 cm), two-part metal column for three different heights, quickly convertible even for considerable variations in ratio or exchange of lenses. Critical focusing by means of rack-and-pinion mechanism on focusing slide. Practical lighting equipment with two reflectors, for both the Repro Stands to be delivered separately.

Photomicrography with Repro Stand: see page 8.

Finger print"
 Photo by Eberhard Buschmann, Dresden
 "South Africa 1d"
 Photo by Werner Wurst, Dresden

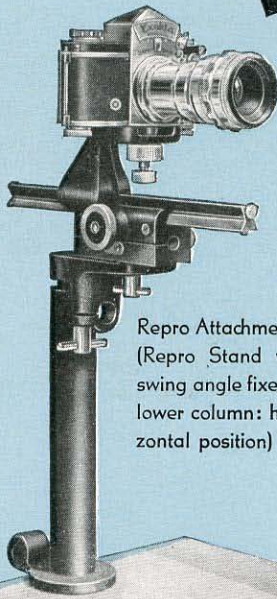

Repro Attachment 2
 (Repro Stand with
 swing angle fixed to
 lower column: hori-
 zontal position)

"Unknown master of the Pflock Altar: St. Sebaldus": Section. In St. Anne's Church at Annaberg/Saxony. Photo by Staatl. Fotothek, Dresden

- | | |
|--|------------------|
| Repro Attachment 1 | Order No. 155.14 |
| Repro Attachment 2 | Order No. 155.15 |
| Repro Stand (baseboard with columns and headpiece) | Order No. 155.01 |
| Repro Stand with focusing slide | Order No. 155.07 |
| Lighting equipment for Repro Attachments 1 and 2 | Order No. 155.05 |

(This type may be supplied, if the customer already possesses the other parts.)

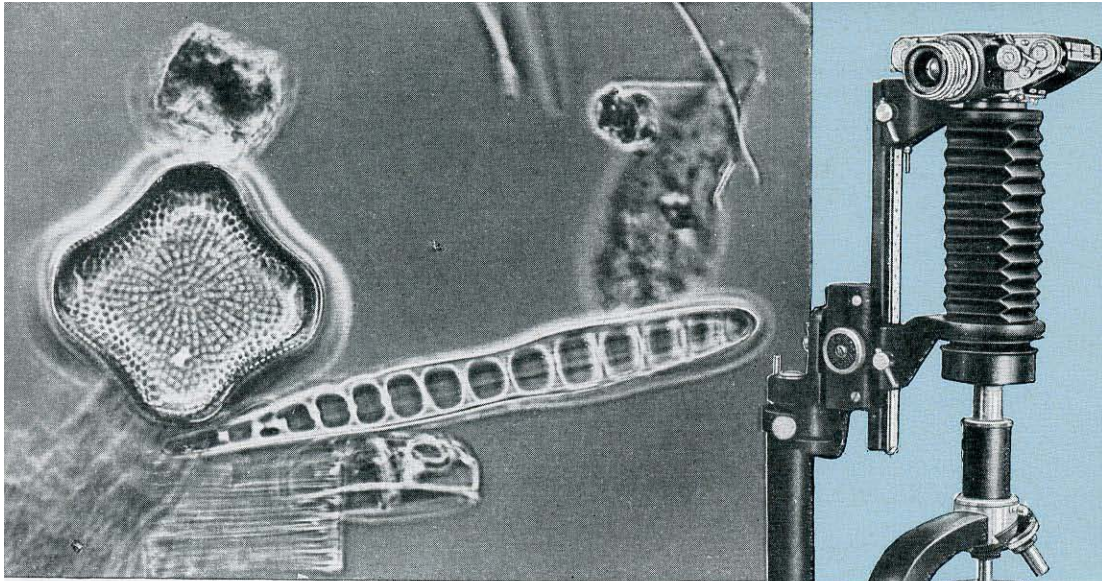

Also photomicrography with the Vielzweck!

The EXAKTA Varex has, up to the present, proved extremely helpful in microphotography. But there are many practitioners who do not like to connect their camera to the microscope by means of any one of the usual microscope adapters. For this reason we recommend the following arrangement:

Fix the EXAKTA Varex without its lens, together with the bellows attachment (see page 4), to the copying stand (see pages 6/7) above the microscope, but without mechanically connecting camera and microscope. Penetration of stray light is avoided by two light-protection tubes which slip into each other without touching (one tube is screwed into the lens holder of the bellows attachment and is supplied with it, whereas the other tube can usually be procured from the microscope manufacturer). The scale of reproduction on the film is adjustable by moving the bellows in the bellows attachment. The image projected by lens and ocular of the microscope is received by the EXAKTA Varex which, as explained before, is used without its lens. A stop ring on the lower column of the copying stand marks the exact position of the camera over the microscope: to suspend photographic work, push the camera aside and swing it back to the stop ring as may be required without readjusting the centering mechanism.

Repro Attachment 1: vertical position,
as used in micro work

Repro Attachment 1
Light-protection tube

Order No. 155.14
Order No. 156

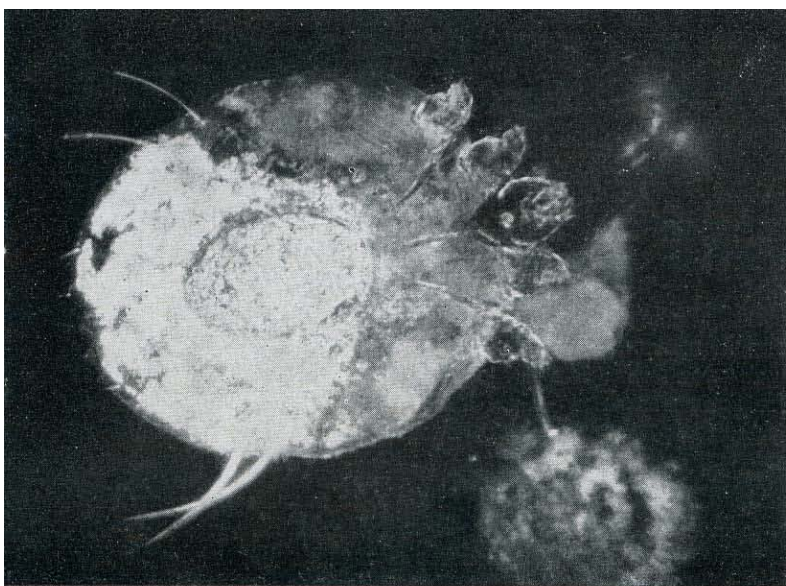

Two micro exposures:
 Left: "Diatomæ"
 (in light field)
 Photo by Dr. Heinz Höring,
 Rochlitz
 Right: "Scab mite"
 (in dark field)
 Photo by Dr. Hans-Lothar
 Kölling, Jena

Tiltproof tripod connection

Where long-focus and heavy lenses – perhaps with additional bayonet rings and tubes – are being used, the entire equipment will not be quite balanced out, which may cause vibration and blurred pictures. The state of equilibrium is restored by using the tripod plate, whereby the camera is given a firm hold. The swing angle top bearing the EXAKTA Varex (see page 4) is fixed to the small gliding rail on the tripod plate and shifted away from the vertical axis of the tripod to the properly balanced position. This moving of the camera is a great asset in close-up work, inasmuch as the lens distance may be changed without altering the position of the tripod. The tripod plate is provided with continental and English socket and, by means of the swing angle, the camera can, as required, immediately be switched from the horizontal to the vertical, or vice versa.

Tripod plate Order No. 155.13
 Swing angle top*) Order No. 155.03
 (without focusing slide)

*) When ordering, please state whether the camera in use has continental or English tripod socket.

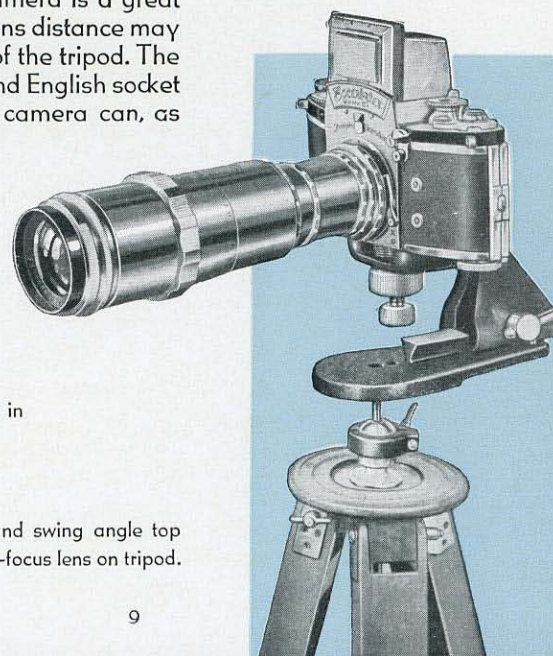

Tripod plate and swing angle top balancing long-focus lens on tripod.

Magnifier exposures with electronic flash

This specialized type of work is carried out with the help of the "Kolpofot": in the negative, already, the object appears slightly enlarged. The high-speed flash of the shutter-synchronized strobelight ensures extreme sharpness, even with objects in motion. The "Kolpofot" has, therefore, been employed with the greatest success, not only in the medical field, but also in other spheres of scientific photography. It is of outstanding value in photographing cavities of the human and animal bodies (vagina, mouth, throat, etc.), and is gaining more and more importance in research work in the struggle against uterine cancer. Intravaginal exposures made with this set of instruments reveal the finest of structures with amazing clearness. The "Kolpofot" has also been extremely valuable in photographing skin, teeth, the eyes, etc. Focusing is performed with the help of a pilot light.

Equipment and abilities: Bellows attachment, in light-coloured varnish, bright metal parts in chrome finish. Special 135 mm lens, f/4, with diaphragm stops down to f/45, yielding extreme depth of field. Scale of reproduction at an object distance of 20 cm: 1.6 fold enlargement in negative, 7 times larger for focusing, whereby every detail, even in difficult situations, is perfectly recognisable. Central flash unit ZB 3, complete with ring flash tube, pilot light, and 3 cables.

"Kolpofot" complete .. Order No. 155.11
Carrier for Reflector rod .. Order No. 155.12
(This carrier is required if a normal bellows attachment in black-coloured varnish is being used).

Further, you will need with the "Kolpofot": EXAKTA Varex with Penta Prism (clear glass magnifier with hairline cross), an electronic flash unit (500 to 1000 volts), a 6 volt transformer, a sturdy tripod with universal swing-and-tilt head.



Left: "Portio"
 Photo by R. Gansø, M. D., Dresden
 Upper right: White swellings on the gum
 Photo by Dr. Albrecht, Erfurt
 Centre: "Front teeth"
 Photo by J. Landgraf, Dresden

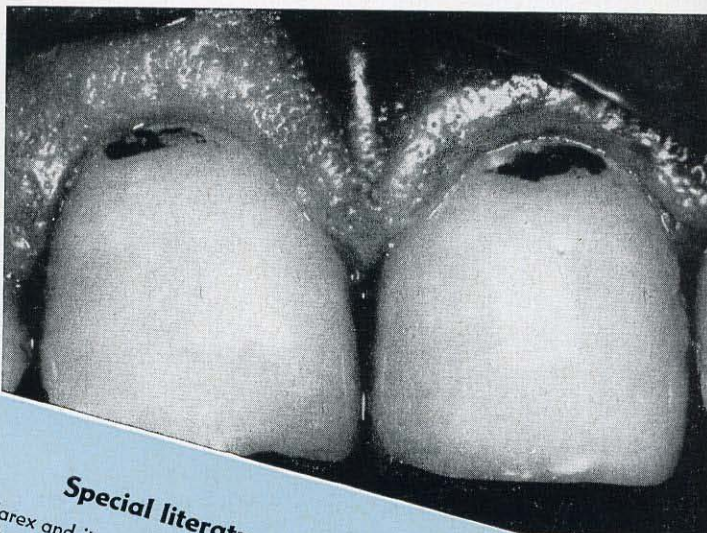
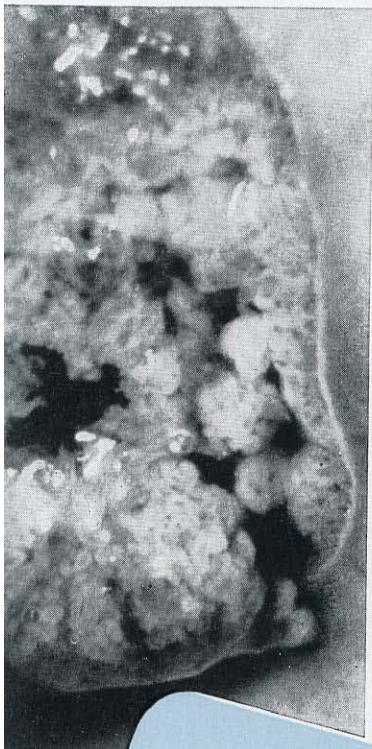

Special literature on the EXAKTA Varex

Prints for the EXAKTA Varex and its accessories, when on hand, are sent, without charges, to interested persons by the Ihagee Kamerawerk AG., Dresden A 16.
 We beg you to let us know which information material you want.
 Books (available in German only at special book stores):
 "EXAKTA Kleinbild-Fotografie" by Werner Wurst. The authoritative, complete instruction book (Published by fotkinoverlag halle, Halle/Saale).
 "EXAKTA Makro- und Mikro-Fotografie" by Georg Fiedler. An indispensable guide for two of the most important spheres of EXAKTA Varex photography (Published by fotkinoverlag halle, Halle/Saale).
 "Kleinbild-Stereo-Nahaufnahmen" by Dr. W. Pietsch. A brochure full of information on three-dimensional photography (Published by fotkinoverlag halle, Halle/Saale).
 "Kolpofotogramme" Volumes 1, 2, 3, by Prof. R. Gansø M.D. An introduction to colpocopy and colpophotography with the EXAKTA Varex (Published by Akademie-Verlag, Berlin NW 7).
 "EXAKTA Tips" by Werner Wurst. A short preliminary study of the EXAKTA Varex (Published by Heering-Verlag, Seebruck/Chiemsee).

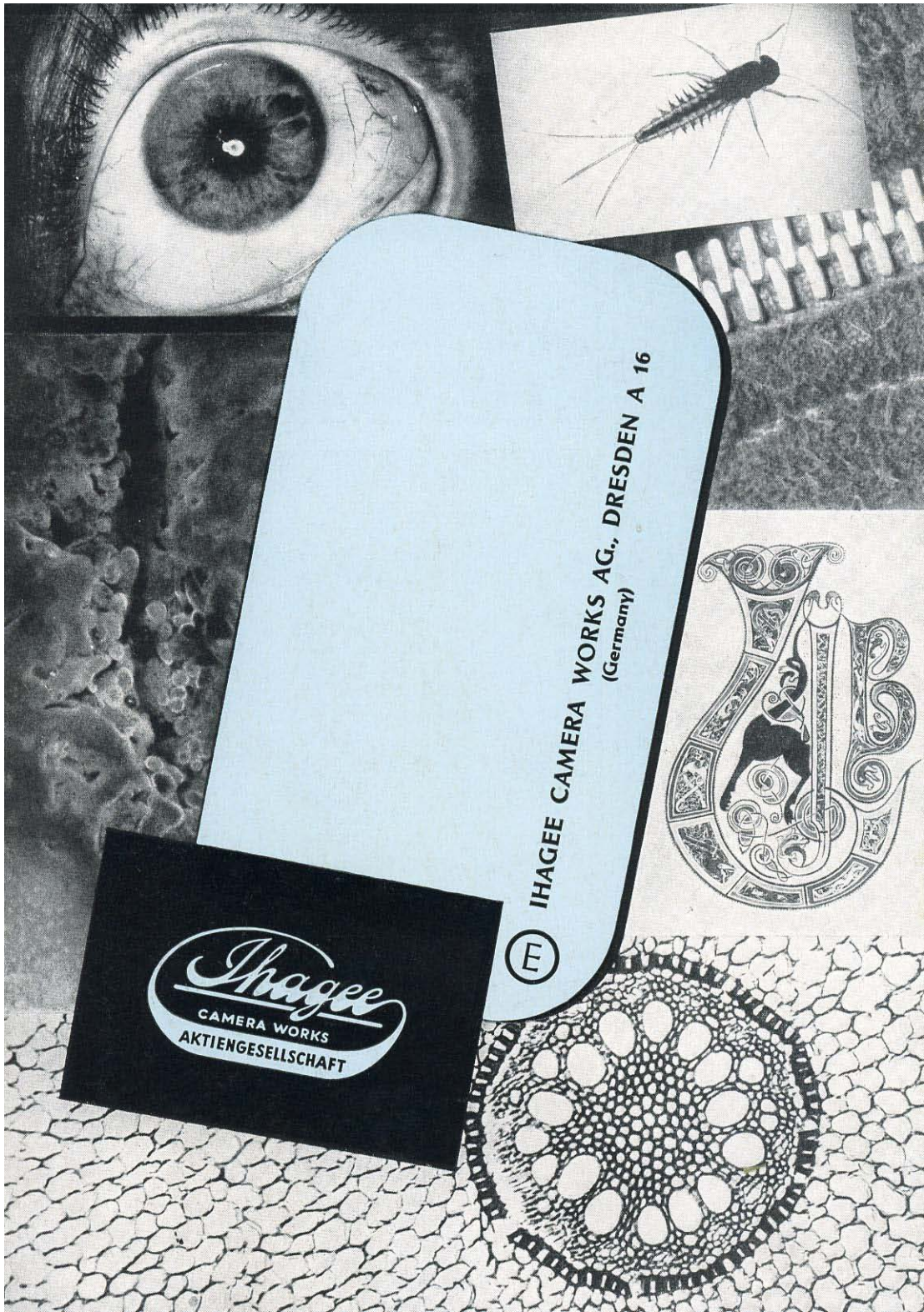

IHAGEE CAMERA WORKS AG., DRESDEN A 16
(Germany)

